

# Data Sheet



Article number: 12521800140500  
Description: KLEE-coil 521 800 140.500  
M4 Stainless 1.4305

## Measures

---

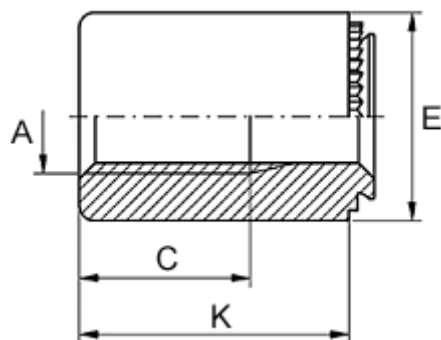

Female thread A	= M4
Height K	= 21
Min distance to edge	= 4.0
Outer diameter E	= 8
Plate thickness	= 1.1 to 1.4
Recommended bore diameter +0.05	= 5.00
Thread length	= 8.0